



INC-C CO₂ Incubator

Please read the User Manual carefully before use, and follow all operating and safety instructions!



user manual

english

User Manual



INC-C CO₂ Incubator

Preface

Thank you for purchasing our product. Users should read this manual carefully, follow the instructions and procedures, and be aware of all preventive measures when using this instrument.

Service

If help is needed, you can always contact your dealer or Labbox via www.labbox.com.

Please provide the customer service representative with the following information:

- Serial number
- Description of the problem
- Your contact information

Warranty

This instrument is guaranteed to be free from defects in materials and workmanship under normal use and service for a period of 24 months from the date of invoice. The warranty is extended only to the original purchaser and shall not apply to any product or parts that have been damaged due to improper installation, improper connections, misuse, accidents, or abnormal conditions of operation.

For claims under the warranty, please contact your supplier.

1. Application Range:

The INC-C CO₂ Incubator is suitable for use in modern medicine, biochemistry, agricultural science research, and industrial production departments, for the cultivation of biological cells, tissues, and bacterial cultures.

2. Features:

1. This product is made of high-quality thermal insulation materials and adopts a water jacket structure, with an air duct liner and fan forced convection that ensures uniform box temperature and equilibrium CO₂ concentration.
2. It uses first-class imported CO₂ sensors that detect infrared waves and have gold-plated probes, ensuring measurement accuracy and a sensor life of up to 15 years.
3. The indoor CO₂ concentration can range from 0 to 20%, and a gas filter is used to improve measurement accuracy and room cleanliness and to reduce the effect of impurities on CO₂ gas concentration.
4. The fans and CO₂ valve automatically turn off when the door is open, and heating stops, reducing CO₂ gas consumption, and preventing air pollution caused by the entry of impurities.
5. The temperature and CO₂ concentration are controlled by intelligent PID control and computer data analysis, ensuring high precision and strong anti-interference. The temperature control uses two probes to control the temperature inside and outside the door, ensuring high precision and minimal fluctuations.
6. The adjustment switch is light and flexible to operate.
7. The independent temperature control door reduces the external temperature and prevents frost on the system of the studio and glass doors.
8. The natural evaporation humidifier maintains good indoor humidity.
9. The box temperature, CO₂ concentration, and set parameters are displayed digitally, and the LED instruction indicates door heat, CO₂ entering the air, high-water level, and water shortage.
10. The equipment is equipped with protection features such as super warm and breathe, ensuring safe operation.

3. Specifications:

- Temperature Control Range (°C): RT+3~60
- Timing Range: 1~9999 min or no time
- Electric Power: AC220V 50Hz
- Temperature Fluctuation (°C): $\leq \pm 0.2$
- Temperature Uniformity (°C): $\leq \pm 0.3$
- CO₂ Concentration Control Range (%): 0~20
- CO₂ Accuracy (%): $\leq \pm 0.1$
- Time to reach the set CO₂ value: <10 min (5 % concentration)
- CO₂ Measurement Precision (%): ± 0.1

Other technical parameters can be seen in the following table :

| Model | INCC-080-001 |
|--------------------------------|------------------|
| Volume (L) | 80 |
| Power (W) | 600 |
| Studio Size (cm ³) | 41 x 51 x 40.3 |
| Dimensions (cm ³) | 57 x 88.5 x 59.5 |
| N.W/G.W (kg) | 60/90 |

4. Installation:



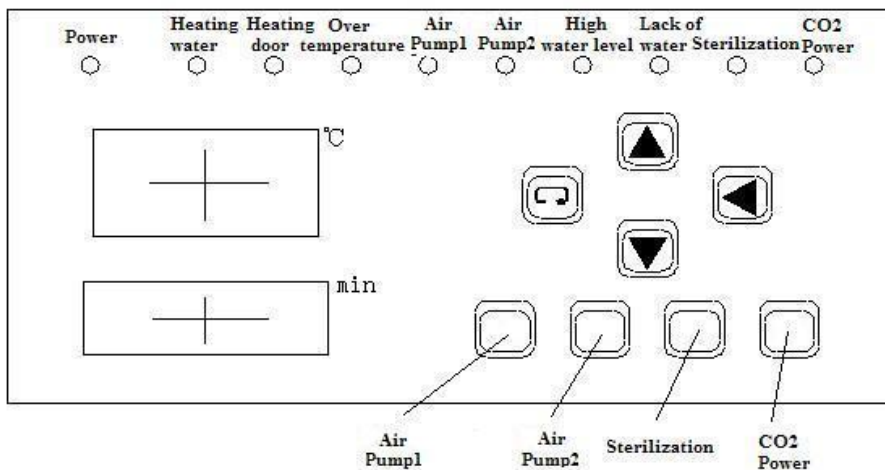

1. The equipment should be placed in a dry, flat area that is free from toxic and hazardous gases. It should be kept away from direct sunlight and have enough space around it for easy maintenance.
2. To use this equipment, you must equip it with 99.9% high purity gas cylinders and a CO₂ valve (users must provide these components themselves). The cylinders should be placed near the incubator and connected to the "CO₂ into the air intake" with silicone hoses.
3. The incubator works best at an ambient temperature of 20 ~ 25 °C. Set the minimum temperature of the incubator to at least 5 °C higher than the ambient temperature.
4.  The incubator must be plugged into a reliable grounding power outlet and matched with the correct plug.

5. Operating Instructions of the Temperature Controller:

1. Panel Diagram (Equipped Instruments, CO₂ Temperature Controller)













2. On the right of the panel is a set of keys, the functions are following:

1.  Key: This key is a function key, after powered on, press this button to enter the temperature setting state. Press this button for five seconds to enter the other parameters setting state. When the instrument is in the set state, the bottom LED will flash.
2. "Air pump 1" Key: Click the button to connect pump 1, press it again to disconnect pump 1.
3. "Air pump 2" Key: Click the button to connect pump 2, press it again to disconnect pump 2.
4. "Sterilization" Key: Click this button, and the indoor sterilization lights will turn on. Click it again, and the sterilization lights will turn off.
5. "Lighting" Key: Click this button to turn on the lights and click it again to turn off the lights.
6.  Key: This key is the addend key. When setting parameters, press the button to increase the value by 1.
7.  Key: This key is the subtraction key. When setting parameters, press the button to decrease the value by 1.
8.  Key: This key is the left key. When setting parameters, press the key to move to the data bit that needs to be set. In the boot state, click the button to view the indoor temperature.

Note: Please press the key  after setting parameters, otherwise the parameters cannot be written to memory.

3. Instructions:

1. When running, the temperature window (top row) displays the inside temperature. The time window (bottom row) displays the remaining time. When the time is set to zero, the time window displays the set temperature. When the remaining time reaches 0, it displays "end" and stops running. To rerun it, press the  key.
2. To set the inside temperature and run time, follow these steps: ① Press the  key, and the top row of the digital display will show the temperature settings, while the end-term blinks. → ② Use the ▼, ▲ and ◀ keys to modify the status. → ③ Press the  key to display the set time on the bottom row of the digital display. → ④ Use the ▼, ▲, and ◀ keys to modify the time status. → ⑤ Once you've set the parameters, use the  key to write them into memory, exit the setting state, and return to running.
3. Set other parameters as follows: ① Press the  key for about 5 minutes to enter the other parameter setting state. The top row of the digital display will show each parameter symbol, and the bottom row will show the parameter settings. The end-term will be in a flashing state. → ② Use ▼, ▲ and ◀ keys to modify the time status. → ③ Press the  key to write the parameters into memory and adjust the next parameter in the same way. → ④ After setup is complete, press the  key for about 5 minutes to exit the setting state and return to running.
4. Set the PID parameters as follows: ① Press the  key for about 5 minutes to enter the other parameter setting state, then press the ◀ key for about 5 minutes to enter the PID parameter setting state. The top row of the digital display will show each parameter symbol, and the bottom row will show the PID parameters. The end-term will be in a flashing state. → ② Use ▼, ▲ and ◀ keys to modify the time status. → ③ Press the  key to write the parameters into memory and adjust the next parameter in the same way. → ④ After setup is complete, press the  key for about 5 minutes to exit the setting state and return to running.
5. Check indoor temperature: While the device is running, press the ◀ key to check the indoor temperature. The temperature window will display the current temperature, and three LEDs will flash simultaneously. Press the ◀ key again to return to the default display of the inside temperature.

6. Definition and Instructions for Other Parameter Symbols:

| Symbol | Setting Range | Instructions | Factory Settings |
|--------|---------------|--|------------------|
| AL | 0~10.0 °C | Over-temperature alarm | 1.0 °C |
| SC | -10.0~10.0 °C | Measurement error correction | Random |
| Td | -10.0~10.0 °C | Temperature difference between the door and the box | Random |
| TS | 0~10.0 °C | Temperature difference between the water and the box | Random |
| TT | 0~300 °C | Closed heating delay time | Random |

Definition and Instructions for PID Parameter Symbols:

| Symbol | Setting Range | Instructions | Factory Settings |
|--------|---------------|--|------------------|
| P1 | 0~50.0 °C | Advance amount of temperature controller inside the box (proportional limit). | Random |
| I1 | 1~2500 S | Integration time of the temperature inside the box. | Random |
| D1 | 1~1000 S | Differential time of the temperature inside the box. | Random |
| P2 | 0~50.0 °C | Advance amount of temperature controller inside the door (proportional limit). | Random |
| I2 | 1~2500 S | Integration time of the temperature inside the door. | Random |
| D2 | 1~1000 S | Differential time of the temperature inside the door. | Random |

4. Wiring Diagram

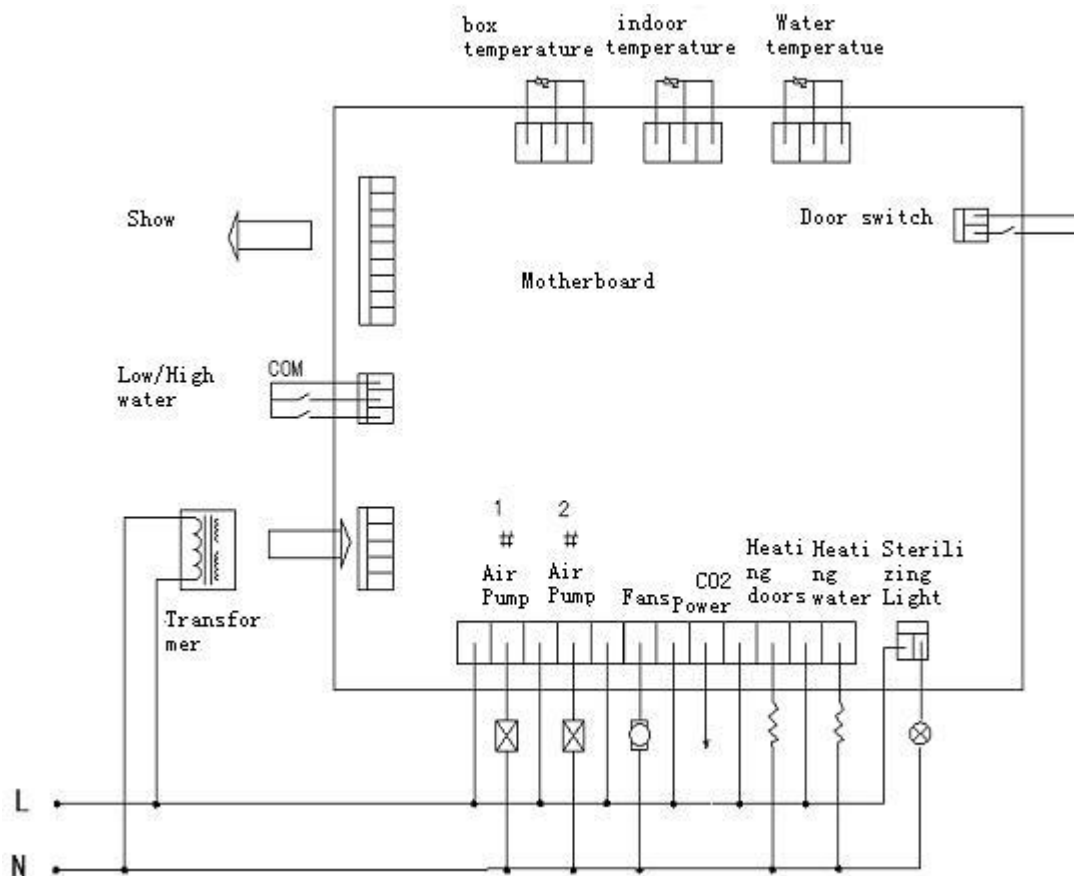

5. Notes:



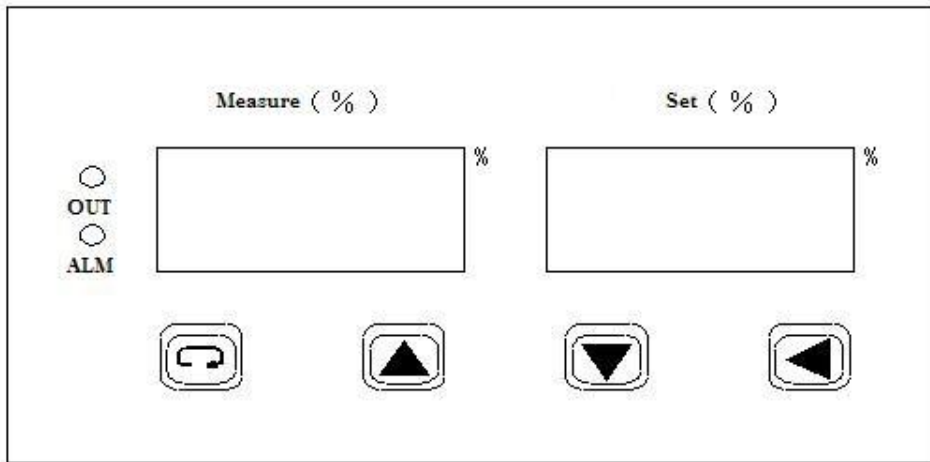

1. If the sensor inside the box is disconnected or short-circuited, the temperature display will show ER1. If the sensor inside the door is disconnected or short-circuited, the temperature display will show ER2. If the sensor in the water is disconnected or short-circuited, the temperature display will show ER3. If the water level is detected incorrectly, the temperature display will show ER4, and the buzzer will continuously sound an alarm.
2. If the measured temperature is $>$ Set temperature + AL, the buzzer will sound intermittently. If the measured temperature is $<$ Set temperature + temperature alarm value, then the buzzer will stop sounding. Press any key to cancel the over-temperature alarm sound.

6. Concentration Controller Operating Instructions:

1. Panel Diagram (Equipped Instruments, CO₂ Concentration Controller)





















2. Below the panel is a set of keys, with the following functions:

1.  Key: This is a function key. After being powered on, pressing this button enters the temperature setting state. Pressing this button for five seconds enters the other parameter setting state. When the instrument is in the set state, the LED at the bottom will flash.
2.  Key: This key is the addition key. When setting parameters, pressing the button adds 1.
3.  Key: This key is the subtraction key. When setting parameters, pressing the key subtracts 1.
4.  Key: This key is the left key. When setting parameters, the key can move to set the data bit.

Note: Please press the  key after setting parameters, otherwise the parameters will not be written to memory.

3. Instructions:

1. When running, the measurement window shows the CO₂ concentration, and the setting window shows settings.
2. To set the desired CO₂ concentration level, follow these steps: ① Press the  key, and the right digital display will show the current settings, with the end-term blinking. → ② Use , , and  keys to modify the time status. → ③ Once you have set the desired parameters, press the  key to write them into memory, exit the setting state, and return to the running state.
3. Set other parameters as follows: ① Press the  for about 5 minutes to enter the other parameter setting state. The left digital display will show each parameter symbol, while the right digital display will show the parameter settings. The end-term will be in a flashing state. → ② Use the , , and  keys to modify the time status. → ③ Press the  key to write the parameters into memory and move on to the next parameter. → ④ After setting up all the parameters, press the  key for about 5 minutes to exit the setting state and return to running.

4. Set the PID parameters as follows: Press the  key for about 5 minutes to enter the other parameter setting state, and then press the  key for about 5 minutes to enter the PID parameter setting state. The left digital display will show the symbol of each parameter, and the right digital display will show the current value of the PID parameters. The end-term will blink. → ② Use the , , and  keys to modify the time status. → ③ Press the  key to write the parameters into memory and adjust the next parameter, and so on. → ④ After setting up is complete, press the  key for about 5 minutes to exit the setting state and return to running.
5. Definition and Instructions for Other Parameter Symbols:

| Symbol | Setting Range | Instructions | Factory Settings |
|--------|---------------|---|------------------|
| AL | 0~10.0 °C | CO ₂ over-concentration alarm. | 1.0 °C |
| SC | -10.0~10.0 °C | Measurement error correction. | Random |

Definition and Instructions for PID Parameter Symbols:

| Symbol | Setting Range | Instructions | Factory Settings |
|--------|---------------|--|------------------|
| P | 0~20.0 % | Advance amount of controller (proportional limit). | 2.5% |
| I | 1~999 S | Integration time. | 400 |
| D | 1~999 S | Differential time. | 100 |

4. Wiring Diagram:

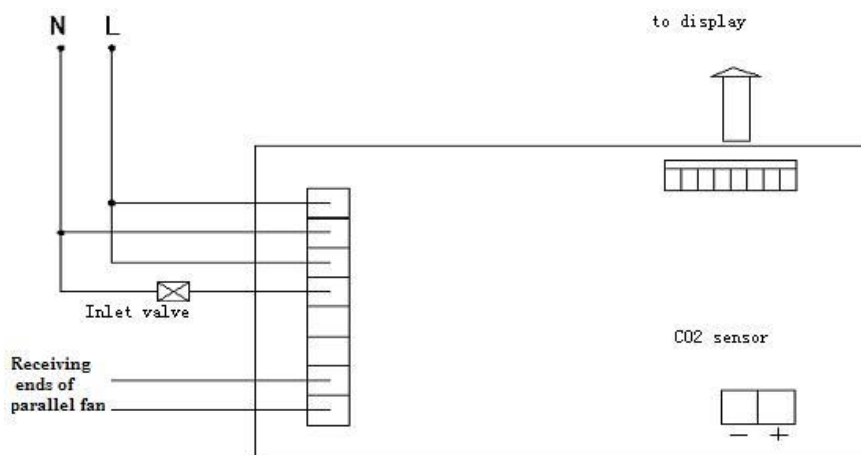





5. Notes:

1. Output indicator: The light is on when the inlet solenoid valve is switched on. When the Inlet solenoid valve is open, the light is off.
2. Alarm indicator: If CO₂ concentration inside the box is $>$ set concentration + AL, the light is on and the buzzer intermittently alarms. If the CO₂ concentration increases too slow, the buzzer intermittently alarms, and the lights keeps flashing.
3. Alarm description: If the CO₂ concentration detected exceeds the calibration range (greater than 30 %), the measurement window displays ERR and the buzzer continuously alarms.
4. If the CO₂ concentration inside the box is $>$ set concentration + AL, the buzzer intermittently alarms. If the CO₂ concentration inside the box $<$ set concentration + AL, the buzzer stops the alarm. Press any key to cancel the over-temperature alarm.
5. When the CO₂ concentration increases too slowly, the buzzer intermittently alarms and cannot be cancelled.
6. When the fan is powered off, the CO₂ output is automatically turned off. When the fan is powered on, the CO₂ concentration is controlled automatically.

7. Order of Operations for Use:

- 1. Irrigation:** Connect one end of the rubber tube to the “inlet, outlet” valve at the back of the device and the other end to a water source. Open the “inlet, outlet” valve and let the water pressure fill the water jacket. When the injected water exceeds 12 liters (the water level exceeds the heating tubes), you can connect the power and continue to inject water while observing the water level indicator (low water level may trigger an alarm) until the high-water level indicator light turns green. Then, stop injecting water, turn off the “inlet, outlet” valve. Alternatively, you can inject water into the overflow until the water overflows and then release a little water.
- 2. Please use only pure water or distilled water to prevent scaling inside the water jacket.**
- 3. After installing the incubator and irrigating it with water, you can operate it according to the following steps:**
 1. Open the door, clean the studio, and put away the shelf.
 2. If humidity is required, the humidity tray will need to be filled with two-thirds of water and placed at the bottom of the studio. Then close the door.
 3. Open the power switch behind the control box. At this time, the incubator should display the temperature and the high-water level indicator light should be on.
 4. Press the “sterilization” key to sterilize the studio. Note: Do not press this key when there are cultures inside! After sterilization, press the “sterilization” button again and close the germicidal lamp.
 5. First, set the required temperature for heating the incubator (see the temperature controller operating instructions in section V).
 6. Wait until the temperature is constant, then open the door and place the culture inside the box.
 7. Press the “CO₂/power” button to turn on the CO₂ control power supply.
 8. First, set up the required percentage of CO₂ concentration (see VI concentration controller operating instructions).
 9. Open the switch of the CO₂ gas cylinder, and slowly adjust the CO₂ valve so that the second pressure gauge indicates about 0.06 Mpa. If the pressure is too high and the CO₂ concentrations rise too fast, it will increase the fluctuation range. If the pressure is too low and the CO₂ concentrations rise too slowly, it will cause an alarm. Open the regulator valve (turn clockwise to open). Generally, it was already opened before being sent out. The concentration can gradually increase after 1 minute, and it can reach 5.0 % after 10 minutes (when the set value is 5.0 %).
 10. When working, if cleanliness is required, you can alternate between opening pump 1 and pump 2 for the inner loop filter.
- 4. When the incubator stops working, please follow these steps:**
 1. Close the switch of the CO₂ gas cylinder and the reducing valve.
 2. Turn off the CO₂ control power and the pump power in order to stop the CO₂ control panel and pump from working.
 3. Open the door, remove the humidity tray, and hold down the door switch by hand to allow the incubator to work for a few minutes to disperse the water vapor in the box.
 4. Close the door and let the incubator continue heating for about 10 minutes, then turn off the power and clean the inside.

8. Notes:

1. The equipment should be installed in a clean place with minimal temperature fluctuations.
2. Before powering it on, you should thoroughly read and understand the manual to master the correct usage of the component parts.
3.  The control box at the rear of the unit is equipped with fuses. If the device does not power on, check if the fuse tube is intact. When checking and replacing the fuse tube, cut off the power and replace it with the same model specification.
4. When the incubator has no water, it cannot be turned on to prevent damage to the internal parts.
5.  When there are cultures inside the incubator, do not turn on the germicidal lamp to avoid damaging the culture. Turn off the power when replacing the lamp.
6. The membrane needs to be replaced about once every six months. Note the direction of import and export when replacing it, and replace two 0.45 μ filters and two non-woven filter cloths one by one. Tighten the filter to avoid leaks after replacement.
7. Please do not randomly adjust the regulator valve behind the control box, as it may affect the CO₂ concentration control. If the CO₂ concentration increases too slowly or too quickly, you can adjust the regulator valve by turning it clockwise to increase and counterclockwise to decrease.
8. Connect the CO₂ gas cylinder to the incubator inlet with a hose and fasten it to prevent leakage. The second reducing valve should be adjusted within 0.06~0.08 MPa, and the maximum should not be greater than 0.1 Mpa.
9. If the caisson pressure of the CO₂ cylinder is too low to generate unstable flow, it should be reversed or re-inflated before use.
10. To save energy and extend the lamp's life, the "light" switch can be switched on and off as needed.
11.  The equipment must be grounded well. Before using, check the power ground stringently.
12. The machine is equipped with an electromagnetic pump.  Turn off the power when exchanging the pump.
13. To reduce temperature fluctuations and ensure uniformity after the studio is closed, a delay of about 10 minutes is necessary after closing (the delay time can be set according to actual needs). When the equipment starts to heat up, please avoid frequently opening the door.
14. Please drain the water in the water jacket when the equipment is unused for long periods.

9. Storage and Transportation:

The incubator should be stored in a well-maintained room with a relative humidity of less than 80% and free of corrosive gases. During transportation, necessary protective measures should be taken to prevent shock and moisture. The incubator should not be transported upside down and should be handled with care.

10. Troubleshooting:

| Phenomenon | | Reason | Treatment |
|--|-----|---|--|
| 1. Power alarm | | Broken sensor. | Refer to phenomenon 2. |
| | | Insufficient water level. | Continue to add water until the high water level indicator turns on. |
| 2. Box temperature display | ER1 | Faulty sensor or open studio. | Check the wiring or replace the sensor. |
| | ER2 | Faulty sensor or open circuit within the door. | Check the wiring or replace the sensor. |
| | ER3 | Broken temperature sensor or open circuit. | Check the wiring or replace the sensor. |
| | ER4 | Short circuit or disconnected wiring for water level. | Check the wiring and measuring probe. |
| 3. No power | | Unplugged or disconnected plug. | Make sure the plug is properly plugged in or the line is properly connected. |
| | | Blown fuse. | Replace the fuse with the same model. |
| 4. No heating | | Lower temperature set. | Adjust and set temperature. |
| | | Improperly closed door or door switch failure. | Close the door, replace, or adjust the door switch. |
| | | Malfunctioning heater. | Replace the heater with the same model. |
| 5. CO ₂ alarm | | Low pressure in CO ₂ cylinder. | Adjust the valve to 0.06~0.08 MPa. |
| | | Slow increase in CO ₂ concentration. | If the regulator valve adjustment is too small, adjust it clockwise. |
| | | CO ₂ concentration exceeds limit. | If the regulator valve opening is too big, adjust it counterclockwise and transfer to a small regulator valve. |
| 6. CO ₂ concentration does not rise | | Door not closed properly (fan switch not turned on). | Open the door or adjust the door switch. |
| | | Broken sensor. | Replace the sensor with the same model. |
| | | Broken solenoid valve | Replace the solenoid valve. |
| 7. Temperature display not allowed | | Uncorrected | Make corrections according to the instructions. |
| 8. CO ₂ concentration not allowed | | Uncorrected | Make corrections according to the instructions. |



Note: The above maintenance operations should be performed by someone who is qualified to operate. Turn off the power when making repairs!

Packing List

| No. | Descriptions | Categories | Quantities |
|-----|---|------------------|------------|
| 1 | CO ₂ Incubator (INCC-080-001) | Machine | 1 |
| 2 | Humidity pan | Fittings | 1 |
| 3 | Shelf | Fittings | 2 |
| 4 | Silicone tube for CO ₂ gas filling | Fittings | 1 |
| 5 | Rubber tube for water filling | Fittings | 1 |
| 6 | Gas filters membrane (5μ) | Backup | 4 |
| 7 | Fuse tube (Φ5×20) | Wearing parts | 1 |
| 8 | Operation manual | Document | 1 |
| 9 | Product certificate | Document | 1 |
| 10 | Warranty card | Document | 1 |
| 11 | Packing List | Document | 1 |

Requirements for Site Commissioning of Carbon Dioxide Incubator

1. The user should supply a 40 L steel bottle of gas with 99.9 % CO₂.
2. The user should supply a CO₂ cylinder reducing valve (with an output of approximately 0.1 Mpa).

Nota importante para los aparatos electrónicos vendidos en España

Instrucciones sobre la protección del medio ambiente y la eliminación de aparatos electrónicos:



Los aparatos eléctricos y electrónicos marcados con este símbolo no pueden ser eliminados en forma de residuos urbanos.

De conformidad con la Directiva 2012/19/UE, los usuarios de la Unión Europea de aparatos eléctricos y electrónicos, tienen la posibilidad de devolver sus RAEE para su eliminación al distribuidor o fabricante del equipo después de la compra de uno nuevo. La eliminación ilegal de aparatos eléctricos y electrónicos es castigada con multa administrativa.

Remarque importante pour les appareils électroniques vendus en France

Informations sur la protection du milieu environnemental et élimination des déchets électroniques :



Les appareils électriques et électroniques portant ce symbole ne peuvent pas être jetés dans les décharges.

En réponse à la réglementation, Labbox remplit ses obligations relatives à la fin de vie des équipements électriques de laboratoire qu'il met sur le marché en finançant la filière de recyclage de ecosystem dédiée aux DEEE Pro qui les reprend gratuitement (plus d'informations sur www.ecosystem.eco).

L'élimination illégale d'appareils électriques et électroniques est punie d'amende administrative.

Nota importante per le apparecchiature elettroniche vendute in Italia

Istruzioni sulla protezione ambientale e sullo smaltimento dei dispositivi elettronici:



Le apparecchiature elettriche ed elettroniche contrassegnate con questo simbolo non possono essere smaltite come rifiuti urbani.

In conformità con la Direttiva 2012/19 / UE, gli utenti dell'Unione Europea di apparecchiature elettriche ed elettroniche hanno la possibilità di restituire i propri RAEE per lo smaltimento al distributore o al produttore di apparecchiature dopo averne acquistato uno nuovo. La rimozione illegale di apparecchiature elettriche ed elettroniche è punibile con una sanzione amministrativa.

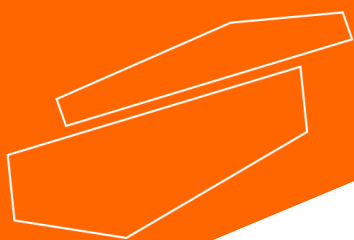

www.labbox.com